

Installation, Operation and Maintenance Instructions



LIFTING MAGNETS

ERIEZ MAGNETICS HEADQUARTERS: 2200 ASBURY ROAD, ERIE, PA 16506-1402 U.S.A.
WORLD AUTHORITY IN SEPARATION TECHNOLOGIES

Introduction

This manual details the proper steps for installing, operating and maintaining Eriez Lifting Magnets.

Careful attention to these requirements will assure the most efficient and dependable performance of this equipment.

If there are any questions or comments about the manual, please call Eriez at 814/835-6000 for lifting magnet assistance.



CAUTION - STRONG MAGNET

This equipment includes one or more extremely powerful magnetic circuits. The magnetic field may be much stronger than the Earth's background field at a distance several times the largest dimension of the equipment.

- **If you use a heart pacemaker or similar device you must never approach the equipment because your device may malfunction in the magnetic field, with consequences up to and including death.**
- **To avoid serious pinch-type injuries caused by objects attracted to the magnet, keep all steel and iron objects well away from the equipment. Do not allow hands, fingers, and other body parts to be caught between the equipment and nearby steel or iron objects.**
- **Keep credit cards, computer disks, and other magnetic storage devices away from the equipment because magnetically stored information may be corrupted by the magnetic field.**
- **Keep electronic devices, such as computers or monitors, away from the equipment because exposure to the magnetic field may result in malfunction or permanent damage to such devices.**

Contact Eriez if you have a question regarding these precautions.



CAUTION

Safety labels must be affixed to this product. Should the safety label(s) be damaged, dislodged or removed, contact Eriez for replacement.

Installation

All lifting magnets are packed for shipping in a manner that provides adequate protection for the pole faces and other critical areas. Eriez Lifting Magnets do not present any potential hazards for magnetic attraction in the “as shipped” condition.

The magnet is typically attached to an overhead lifting device properly rated to handle the maximum magnet capacity. A properly designed or selected clevis, shackle, chain hook or strap is attached through the lifting eye.

The rated load (capacity) of the lifting magnet is clearly marked on the lifting magnet or on a tag attached to it where it is visible. This rating refers to this instruction manual for information relating to decreases in rating due to load thickness, load alloy, load surface conditions, load length or width, attitude of load, portion of lifting magnet face in contact with load and/or load temperature. For more information see *Operation – Factors Affecting Lifting Capacity*. The marked capacity is based on a specific load for which the rating applies.

Inspection

Inspect the pole faces carefully for evidence of damage in shipment. Nicks or burrs that would prevent the poles from fully contacting a flat, smooth plate should be sanded, filed or machined, if necessary. Determine whether or not any parts are obviously missing or broken and, if so, do not attempt to use the magnet until corrective action is taken.

Suspension or Mounting

For normal lifting applications, some flexibility in the mounting is desirable. This is particularly beneficial when more than one magnet is on a beam or fixture because, if the workpiece is not level, the magnets can align themselves to the workpiece as they are moved into position. The degree of flexibility should be controlled so that no damage will occur to the magnet, beam or wiring if the load should suddenly break away from the magnet. The suspension design should consider and prevent situations in which one or more magnets may actually be lifted by the remaining magnets due to flexing of the beam or the load. There are numerous ways of achieving flexibility and it is suggested that Eriez be consulted on a method best suited for the specific application.

If the installation is of the multiple-magnet type, it is important for safety that the pole faces of all magnets be in firm contact with the load. Usually this requires that the pole faces lie in exactly the same plane when unloaded.

Wiring

Always use wire of adequate size to conduct electric power to the magnet. Undersized wiring will create a potential fire hazard due to excess heating and ultimate failure of the insulation. Be sure the power connected to the magnet matches all the electrical characteristics on the nameplate. Otherwise, components may be damaged and failures will occur.

Eriez magnets have provision for grounding through the power cord or in the junction box. Electrical short circuits are always a possibility wherever electricity is used, but the damaging consequences of a short will be much less if proper grounding is provided.

Wire size, grounding techniques and circuit protection can be determined by a competent electrician. Don't take chances on improperly wired systems.

Connect the two DC leads from the DC power source to the terminals in the magnet outlet box.

NOTE: Either wire from the DC power source can be connected to either terminal post in the outlet box, unless indicated on the magnet. Do not break the DC leads from the DC power source with a switch or fuses. The energy from the magnet must have a decay path either through power source, or a free wheeling diode connected across the coil in a blocking direction. Consult Eriez Engineering Department for further information.

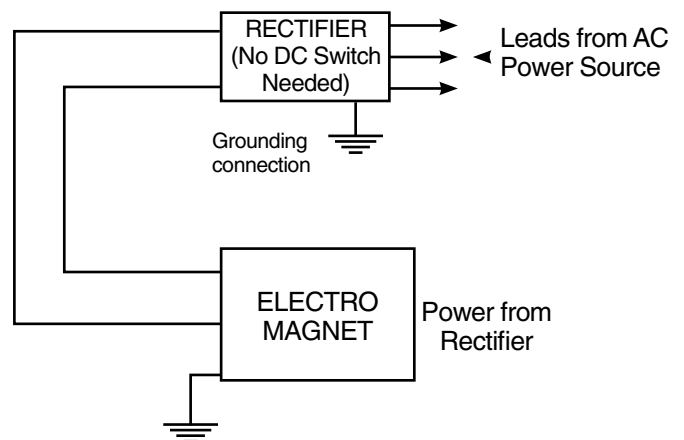

Inspection

Inspection Classification

Initial Inspection

- New and reinstalled lifting magnets shall be inspected by a designated person prior to initial use to verify compliance with applicable provisions of this manual.
- Altered, repaired or modified lifting magnets shall be inspected by a designated person. The inspection may be limited to the provisions affected by the alteration, repair or modification, as determined by the qualified person.

Inspection Intervals

Inspection procedures for lifting magnets in regular service are divided into three general classifications, based upon the intervals at which the inspections shall be performed. The intervals, in turn, are dependent upon the nature of the critical components of the lifting magnet and the degree of their exposure to wear, deterioration or malfunction. The three general classifications are designated as every lift, frequent and periodic, with respective intervals between the inspections as defined below.

- Every Lift Inspection: Visual examination by the operator before and during each lift made by the lifting magnet.
- Frequent Inspection: Visual examination by the operator or other designated persons with records not required.
 - Normal service – monthly
 - Heavy service – weekly to monthly
 - Severe service – daily to weekly
- Periodic Inspection: Visual inspection by a qualified person making records of apparent external conditions to provide the basis for a continuing evaluation.
 - Normal service – yearly
 - Heavy service – quarterly, unless external conditions indicate that disassembly should occur to permit detailed inspection
 - Severe service – monthly, unless external conditions indicate that disassembly should occur to permit detailed inspection

- Special or infrequent service – as recommended by a qualified person before the first occurrence and as directed by the qualified person for any subsequent occurrences

Every Lift Inspection

Items such as the following shall be inspected by the operator before and/or during every lift for any indication of damage as specifically indicated, including observations during operation for any damage that might occur during the lift:

- Lifting magnet face and surface of the load for foreign materials and smoothness
- Condition and operation of the control handle of a manually controlled permanent magnet
- Condition and operation of indicators and meters when installed

Frequent Inspection

Items such as the following shall be inspected for damage at intervals as defined above, including observations during operation for any indications of damage that might appear between inspections. A qualified person shall determine whether any indications of damage constitute a hazard or will require more frequent inspection. For all lifting magnets, inspect:

- Structural and suspension members for deformation, cracks or excessive wear on any part of the lifting magnet
- Lifting magnet face for foreign materials and smoothness
- Condition of lifting bail or sling suspension
- Condition and operation of control handle
- Condition and operation of indicators and meters, where applicable
- Cracked housings, welds and loose bolts
- Labels and markings
- All electrical conductors that are visible for loose connections, continuity, corrosion and damage to insulation
- For battery operated electromagnets, inspect for proper level of battery electrolytes and for corrosion of posts and connectors



Inspection (cont.)

Periodic Inspection

Complete inspections of lifting magnets shall be performed and recorded at intervals as defined previously. Any deficiencies, such as those listed below, shall be examined by a qualified person and determination made as to whether they constitute a hazard. These inspections shall include the requirements of the above and, in addition, items such as the following:

- All members, fasteners, locks, switches, warning labels and lifting parts shall be inspected for deformation, wear and corrosion.
- All electrical components including meters, indicators or alarms shall be tested for proper operation and condition.
- The lifting magnet coil shall be tested for ohmic and ground readings and compared to manufacturer's standards.

Lifting Magnets not in Regular Use

A lifting magnet that has been idle for a period of one month or more is to be given an inspection in accordance with above before being placed into service.

Inspection Records

Dated inspection reports shall be made on critical items, such as those listed in Periodic Inspections. Records should be available to appointed personnel for each periodic inspection and when the lifting magnet is either modified or repaired.

Repairs

Any indications of damage disclosed by the inspection requirements shall be corrected according to the procedures outlined below before operation of the lifting magnet is resumed.

Testing

Operational Testing

- New and reinstalled lifting magnets shall be tested by a qualified person, or a designated person under the direction of a qualified person, prior to initial use to verify compliance with applicable provisions of this manual, including, but not limited to, the following:
 - Moving parts
 - Latches
 - Stops
 - Switches
 - Any control devices
 - Alarms
- Altered, repaired or modified lifting magnets shall be tested by, or under the direction of, a qualified person. The test may be limited to the provisions affected by the alteration, repair or modification as determined by a qualified person with guidance from Eriez.
- All indicator lights, gages, horns, bells, alarms, pointers and other warning devices shall be tested.
- Dated reports of all operational tests shall be filed

Load Test

- Prior to initial use, all new, modified or repaired lifting magnets shall be tested by a qualified person and a record be furnished confirming the load rating of the lifting magnet.
 - General application lifting magnets shall be required to satisfy the rated breakaway force test. The rated load of the lifting magnet shall be less than 50% of the rated breakaway force measured in this test.
 - Special application lifting magnets shall be required to comply with the application breakaway force test. The specified application load shall be less than 50% of the application breakaway force measured in this test.

Testing (cont.)

- The breakaway force test shall establish the force required to vertically remove the lifting magnet from a low carbon, rolled steel plate of the minimum thickness stated by the lifting magnet manufacturer. The portion of this plate that is in contact with the lifting magnet shall not exceed 125 $\mu\text{in.}$ ($3.2 \times 10^{-3} \text{ mm}$) and be flat within 0.002 in/ft (0.05 mm/m), without exceeding 0.005 in. (0.127 mm) total. The full operating face of the lifting magnet shall be in contact with the steel plate, which shall be between 60°F (15°C) and 120°F (50°C).
- The application breakaway force test shall establish the application breakaway forces of the lifting magnet under the variety of loading conditions for which the lifting magnet is specified. The details of this test should be supplied by Eriez.
- Altered, repaired or modified lifting magnets shall be tested by, or under the direction of, a qualified person. This test may be limited to the provisions affected by the alteration, repair or modification, as determined by a qualified person with guidance from Eriez.

Operation

WARNING

Because the operator inherently works very close to the magnet, THE WORKPIECE SHOULD NEVER BE DROPPED FROM MID-AIR. Release of the workpiece from the magnet may be uneven for any of several reasons, causing rotation of the workpiece and an unpredictable fall path, resulting in serious personal injury or property damage.

SafeHold magnets have a safety latch that locks when the magnet is turned on. This is for the operator's benefit and should never be removed. If damaged, it should be replaced.

CAUTION

The handle on manually operated SafeHold magnets will tend to override the operator's control through part of the stroke. Failure to grip the handle firmly could result in injury.

Operators

The lifting magnet shall be operated only by a trained, designated person.

Qualifications

Qualifications for operators of lifting magnets are as follows:

- The operator shall be instructed in the use of the lifting magnet by a designated person. Instructions should include, but not be limited to, the following:
 - Applications of the lifting magnet to the load and adjustments, if any, that adapt the lifting magnet to various sizes or kinds of loads
 - Instructions in any special operations or precautions
 - The manufacturer's suggested operating procedures
 - Condition of the load required for operation of the lifting magnet, such as, but not limited to, balance, surface cleanliness, flatness, bending and load thickness
 - Storage of the lifting magnet to protect it from damage
 - Not exceeding the rated load of the lifting magnet nor the capacity of the hoisting equipment by the combined weight of the load, lifting magnet and rigging
 - The proper attachment of adapters to lifting magnet for special load handling
- The operator shall demonstrate the ability to operate the lifting magnet as instructed before assuming responsibility for using the lifting magnet

Conduct of Lifting Device Operators

- The operator shall give attention to the operation of the lifting magnets during a lifting sequence.
- When physically, or otherwise unfit, an operator shall not engage in the operation of the lifting magnet.



Operation (*cont.*)

- Operators shall be responsible for those operations under their direct control. Whenever there is any doubt as to safety, the operator shall consult with the designated person before handling the load.
- The operator shall respond only to instructions from designated persons. However, the operator shall obey a stop order at all times, no matter who gives it.
- The operation of the lifting magnet shall be observed before use and during a shift. Any deficiency observed shall be carefully examined by a designated person. If the deficiency constitutes a hazard, the lifting magnet shall be removed from service and tagged “out of service.” Any indication of a hazardous condition shall be reported to a qualified person for evaluation.
- The operator shall be familiar with standard hand signals when applicable.
- The operator shall land any attached load and store the lifting magnet before leaving the lifting magnet.
- All controls shall be tested by the operator before use during a shift. If any controls do not operate properly, they should be adjusted or repaired before operations are begun.
- The operator shall not ride or allow others to ride loads or the lifting magnet.
- The operator and other personnel shall stay clear of the load. Loads shall be guided by pushing or pulling at the edge in such a manner as to avoid endangering hands or other body parts as the load is lowered, or if it drops.

Lifting Device Operating Practices

- Lifting magnets shall be operated only by the following qualified personnel:
 - Designated persons
 - Trainees under the direct supervision of a designated person
 - Maintenance and test personnel, when it is necessary in the performance of their duties
 - Inspectors (lifting magnet)
 - The lifting magnet shall not be loaded in excess of its rated load or handle any load for which it is not designated.
- The lifting magnet shall be applied to the load in accordance with the instruction manual.
 - Before lifting, the operator shall make sure that lifting magnet ropes or chains are not kinked and that multiple part lines are not twisted around each other.
 - Care should be taken to make certain the load is correctly distributed for the lifting magnet being used.
 - The temperature of the load should not exceed the maximum allowable limits of the lifting magnet.
 - The lifting magnet shall be brought over the load in such a manner as to minimize swinging.
 - Care shall be taken that there is not sudden acceleration or deceleration of the load.
 - Do not allow load or lifting magnet to come into contact with any obstruction.
 - The operator shall avoid carrying the load over people.
 - The lifting magnet shall not be used for side pulls or sliding the load unless specifically authorized by a qualified person.
 - The lifting magnet face and the lifting magnet contact area on the load shall be clean.
 - The load to be lifted shall be within the lifting magnet’s rated load (capacity) or application load (capacity) and lifting equipment rated load (capacity).
 - The operator shall observe all meters and indicators on the lifting magnet to confirm proper operation prior to making a lift.
 - Before starting the lift, the operator shall lift the load a few inches to establish that the load is securely attached to the lifting magnet.
 - All Magnets. Before raising the load more than two inches (50 mm), any adjustable input control should be switched to the “full on” position and remain in this position until the load is removed from the lifting magnet.
 - Before lifting, the operator should confirm that the control handle is in the “lift” or “on” position and the control handle latch is operating.
 - Before lifting, the operator shall warn people near the lift.

Operation (*cont.*)

- The operator should not reenergize the lifting magnet until it has been placed in contact with the next load to be lifted. Prematurely energizing the lifting magnet could cause unwanted materials to be attracted to the lifting magnet.
- The operator shall not leave suspended loads unattended.

Miscellaneous Operating Practices

- An operator shall not use a lifting magnet that is tagged “out of service” or otherwise designated as nonfunctioning.
- “Out of service” tags on lifting magnets shall not be removed without the approval of the person placing them or an authorized person.
- The lifting magnet, when not in use, should be stored at an assigned location.
- Caution should be taken that operating markings or tags shall not be removed or defaced. Missing or illegible markings or tags shall be replaced.

Factors Affecting Lifting Capacity

- **Load Thickness:** The magnetic flux flowing from a lifting magnet into a load increases as the thickness of the load increases. Consequently, as a lifting magnet’s lifting capacity is a function of this flux, the lift capacity increases with load thickness. For every lifting magnet, there is a critical load thickness where all of the lifting magnet’s available flux flows into the load and the lift capacity reaches maximum.
- **Load Alloy:** Many alloys of iron do not accept magnetic flux as easily as do low carbon steels. Consequently, loads of such alloys will not accept all of the flux available in the lifting magnet, which reduces the lifting magnet’s lift capacity.
- **Load Surface Conditions:** Anything that creates an air gap or nonmagnetic separation between a lifting magnet and the load reduces the flux flowing from the lifting magnet into the load, which reduces the lifting capacity of a lifting magnet. A rough surface finish, paper, dirt, rust, paint and scale produces such gaps.

- **Load Length or Width:** As the length or width of the load increases, the load begins to deflect and to peel at the lifting magnet face. This may create an air gap between the load and the lifting magnet, which reduces the lifting capacity as described previously.
- **Attitude of Load:** As the attitude of the surface of the load to which a lifting magnet is attached (lifting surface) changes from horizontal to vertical, the lifting capacity of the lifting magnet reaches a minimum and becomes dependent upon the coefficient of friction of the lifting surface.
- **Portion of Lifting Magnet Face in Contact with Load:** The full face of the lifting magnet must contact the load if the lifting magnet is to achieve maximum capabilities.
- **Load Temperature:** The temperature of the load can cause damage to the lifting magnet and, if high enough, even change the magnetic characteristics of the load. The standard magnet is designed to operate in a -14°F to 122°F (-25°C to 50°C) environment. The load temperature can be between -40°F and 175°F (-40°C and 80°C).



Operation (cont.)

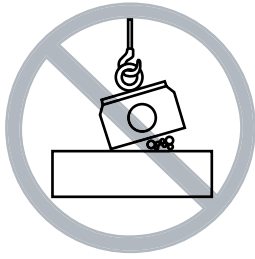

The lifting magnet face and the lifting magnet contact area on the load must be cleaned.



The operator should avoid carrying the load over people.



Nobody must be allowed to stand on top of lifted work-piece.

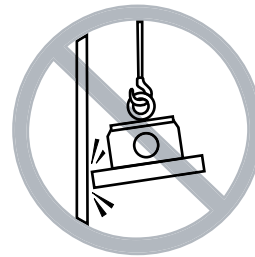

Do not allow load or magnet to come into contact with any obstruction.

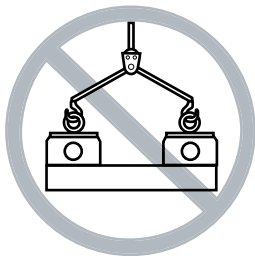

No hooking of two lifting magnets without the use of a properly designed spreader beam.

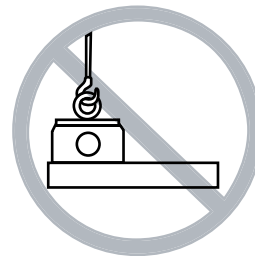

Care should be taken to make certain the load is correctly distributed for the lifting magnet being used.

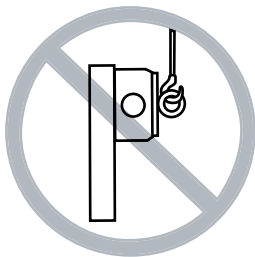

Avoid placing the magnet in shear.

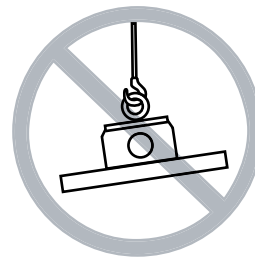

Avoid uneven lifts.

Maintenance

General

Inspect pole faces frequently for burrs, nicks, imbedded foreign objects or accumulation of tramp metal.

Examine suspension hardware at regular intervals. Do not use the magnet if there are defective, badly worn or missing parts. Look for:

1. Worn pins
2. Frayed cables
3. Missing cotter pins
4. Worn chain and shackle links
5. Damaged safety latch or worn hole
6. Loose or broken handle

Maintenance Procedure

- Before adjustment and repairs are started on a lifting magnet, the following precautions shall be taken:
 - All sources of power shall be disconnected and locked out.
 - A lifting magnet removed for repair shall be tagged “out of service.”
- Only qualified personnel shall work on lifting magnet when adjustments and tests are required.
- Replacement parts shall be at least equal to the original manufacturer’s specifications.
- After adjustments and repairs have been made, the lifting magnet shall not be returned to service until it has been inspected according to the above procedure.
- Dated records of repairs and replacements should be made available.

Adjustments and Repairs

Any hazardous conditions disclosed by the inspection requirements shall be corrected before normal operation of the lifting magnet is resumed. Adjustments and repairs shall be done under the direction of, or by, a qualified person.

Electromagnets and Remotely Operated Safehold

Power cables should be inspected regularly for evidence of cut or torn insulation. Switches must be in good operating condition and guards should be in place. Plugs, connectors, sealing glands, strain reliefs and outlet box covers are important items and should not be overlooked.

Remotely Operated and Ratchet Operated Safehold

Normal lubrication of drive parts is required at regular intervals. Frequency of service will depend on severity of use, but in any case, should not be less frequent than:

1. Remote Safehold – weekly application of oil to chain by brush or spout can.
2. Ratchet Safehold – monthly application of grease to gears.

Contact with Work

Lifting magnets, regardless of type, have two things in common:

1. **Pole plates must be in full contact with the work to develop all the magnetic lifting potential for the piece being handled.**
2. **There is a given thickness of workpiece upon which any magnet will develop its maximum lifting capability. When it is used on thinner material, the lifting capacity is reduced. The capability of Eriez magnets is specified on the safety decal.**

Multiple-magnet beams must be used in a manner that will permit all magnets to contact the work. If the end magnet on a beam for long narrow loads is not in contact, the leverage created by the overhanging weight can overload the next magnet and cause the load to progressively strip away from every magnet on the beam. The same action can take place when handling plates. For thinner plates and sheets, the material is more likely to sag from its own weight and cause a peeling action. When Eriez recommends a magnet distribution plan for a multiple system, the above factors are considered. However, Eriez is not always made aware of the intermediate sizes of loads that will not permit use of all magnets on the beam.



Maintenance (cont.)

Multiple Thickness Sheet Handling

Many lifting magnets have a magnetic field that will reach through one or more thin sheets or plates. If more than one sheet is to be handled in a single lift, condition of the material is extremely important. As an example, a given magnet may lift five perfectly flat, clean sheets, whereas it might lift only two of the same sheets if they are warped, bent, covered in scale, etc.

It is good practice to lift a load, stop just a short distance above the pile and use the magnet controller to release the bottom sheet. Safehold magnets cannot be controlled in this manner and consequently are not recommended for multiple sheet handling.



World Authority in Separation Technologies

Headquarters: 2200 Asbury Road, Erie, PA 16506-1402 U.S.A.

Telephone: 814/835-6000 • 800/345-4946 • Fax: 814/838-4960 • International Fax: 814/833-3348

Web Site: <http://www.eriez.com> e-mail: eriez@eriez.com

Manufacturing Facilities: AUSTRALIA • BRAZIL • CANADA • CHINA • INDIA • JAPAN • MEXICO • SOUTH AFRICA • UNITED KINGDOM • UNITED STATES